

# Biometric Full Height Turnstile

FHT2400: Full Height Turnstile

FHT2411: Full Height Turnstile with RFID Access Control System

FHT2422: Full Height Turnstile with Fingerprint and RFID Access Control System

Semi-automatic  
mechanism

Visible indicator

SUS304 stainless  
steel cabinet

Modular design

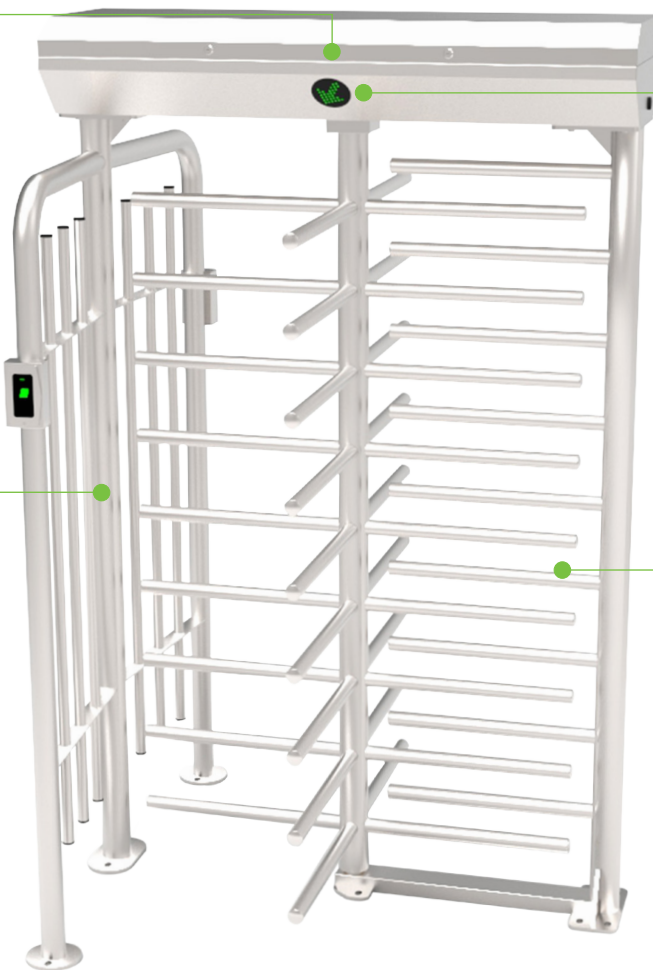

## Application



Industrial facility



Corporate security



Government security



Public transportation

# Specifications

Power requirements	AC110V/220V, 50/60Hz	
Working temperature	-28°C~60°C	
Working humidity	0%~95%	
Working environment	Indoor/Outdoor	
Speed of throughput	RFID	Maximum 30/minute
	Fingerprint	Maximum 25/minute
	Face	Maximum 15/minute
	Vein	Maximum 15/minute
Lane width(mm)	580	
Footprint(mm*mm)	1400*1320	
Dimension(mm)	L=1400 W=1320 H=2220	
Dimension with packing(mm)	1975x925x895&2100x1435x470	
LED indicator	Y	
Cabinet material	SUS304 Stainless Steel	
Barrier material	SUS304 Stainless Steel	
Barrier movement	Rotating	
Emergency mode	Y	
Security level	High	
MCBF	2 million	
Ingress protection	IP54	

# Dimensions (mm)

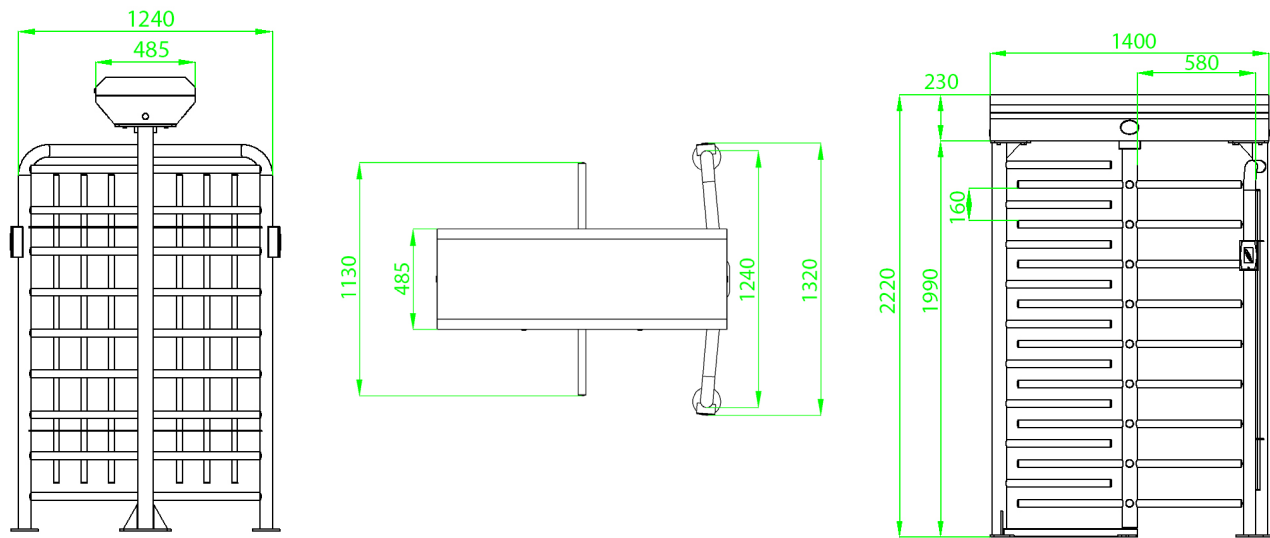

More details

ZKTECO CO.,LTD.  
 E-mail: sales@zkteco.com  
 www.zkteco.com

© Copyright 2015, ZKTECO CO., LTD. ZKTECO Logo is a registered trademark of ZKTECO or a related company. All other product and company names mentioned are used for identification purposes only and may be the trademarks of their respective owners. All specifications are subject to change without notice. All rights reserved.

